

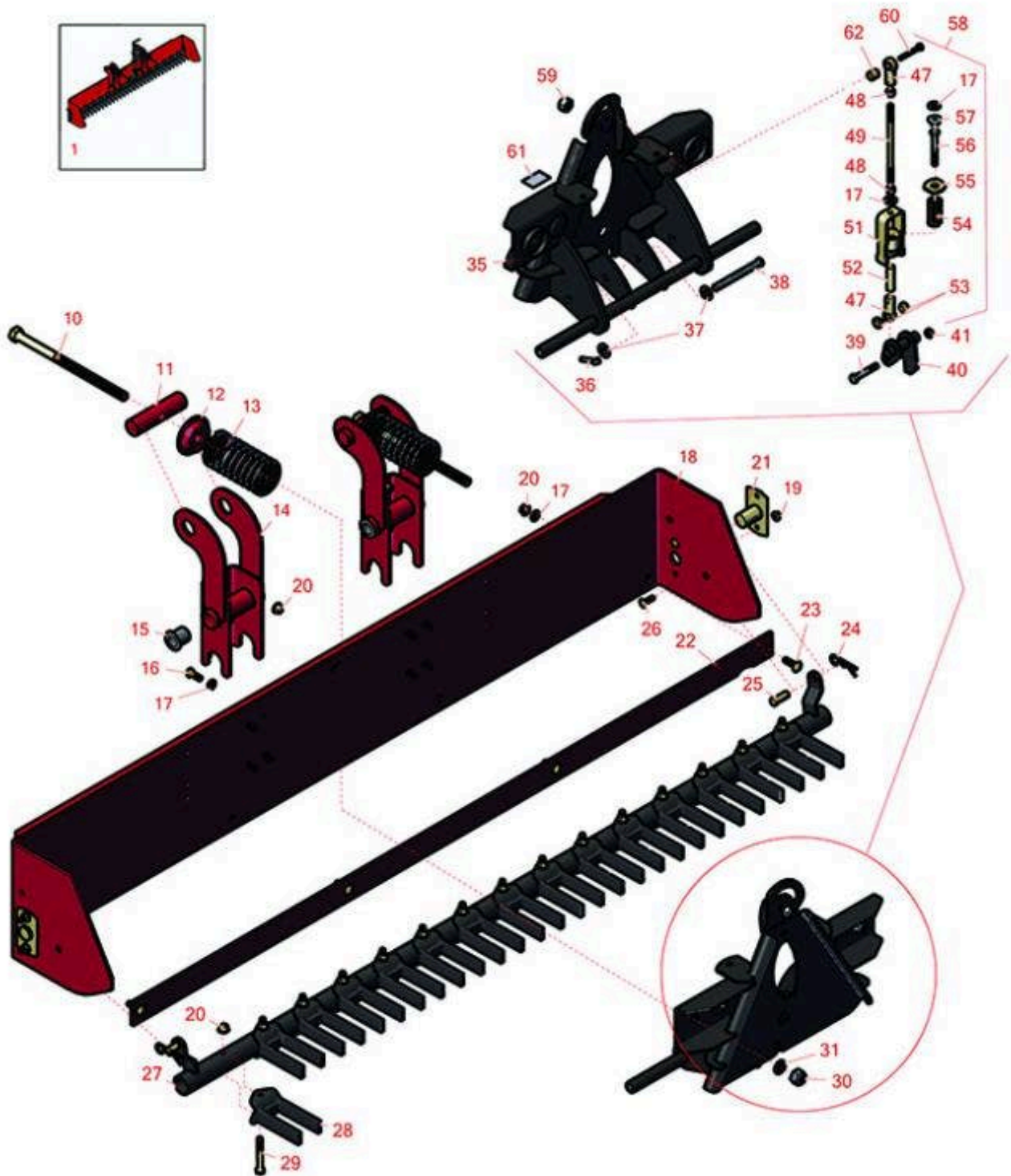

Replaces Toro Sand Pro 3040 Parts

Attachments

Finish Grader - Model 08754



All original equipment manufacturers names and part numbers are used for identification purposes only, and we are in no way implying that our products are original equipment parts. Prices subject to change without notice.



Replaces Toro Sand Pro 3040 Parts

Attachments

Finish Grader - Model 08754



Item No	R&R Part No.	OEM Part No.	Description	Qty Req	Order Quantity
---------	--------------	--------------	-------------	---------	----------------

Complete Finish Grader Attachment Assembly

1	R151097	08754	Finish Grader with Fast Connect Hitch - Red	0	
---	----------------	-------	---	---	--

Detail Description: The Finish Grader is ideal to level, grade and scarify large areas, golf courses and sports fields. The 66" (168cm) wide box grader is equipped with 15 sets of 1.8" (4.5cm) reversible scarifier tines to loosen and break up soil. When not in use, the scarifier tine bar folds away in the box assembly. The Finish Grader features the Rear Fast Connect Hitch Assembly. Red. Available to fit Toro SandPro.:

Other Parts Available

10	R23-2770	23-2770	Rod - Actuating	2	
11	R23-2740	23-2740	Pin - Actuating	2	
12	R108-2288-01	108-2288-01	Support- Spring	2	
13	R20-9420-01	01-261-0600, 20-9420, 20-9420-01	Spring - Compression	2	
14	R112-1400	112-1400	Pivot Assy	2	
15	R95-3577	95-3577	Bushing	4	
16	R323-6	01-150-0010, 01-178-0608, 20-47-AD, 20-47-AGD, 3224-2, 323-6, 49-3510, 908034P, 908332	Bolt - Hex HD 3/8-16 x 1 GR5 YZ	8	

All original equipment manufacturers names and part numbers are used for identification purposes only, and we are in no way implying that our products are original equipment parts. Prices subject to change without notice.



Replaces Toro Sand Pro 3040 Parts

Attachments

Finish Grader - Model 08754



Item No	R&R Part No.	OEM Part No.	Description	Qty Req	Order Quantity
17	R453011	01-166-0100, 01-166-0120, 01-166-0270, 01-166-0500, 01-166-0600, 01-166-0620, 132-4593, 2356-3, 237-12, 24-10-AD, 24-11-AD, 24-11-BD, 24-12-AD, 24-12-BD, 30-9310, 32-8190, 3256-24, 3256-3, 3256-36, 3256-4, 453011, 47-9950, 48-9220, 513458, 7-0052	Washer - Flat 3/8 SAE Y/Zinc	12	
17	R310266	3256-23, 3256-3, 3556-3	Washer - Flat 5/16 USS	3	
17	R453009	01-166-0400, 24-10-BD, 24-9-AD, 32-9650, 3256-2, 3256-23, 3256-3, 3256-67, 3290-217, 3556-3, 4-2390, 7-0152	Washer - Flat 5/16 SAE	3	
18	R108-2928-01	108-2928-01	Box Assy	1	
19	R104-8300	104-8300, 104-8300 , 119-4041	Locknut - 5/16-18 Flanged Y/Zinc	4	

All original equipment manufacturers names and part numbers are used for identification purposes only, and we are in no way implying that our products are original equipment parts. Prices subject to change without notice.



Replaces Toro Sand Pro 3040 Parts

Attachments

Finish Grader - Model 08754



Item No	R&R Part No.	OEM Part No.	Description	Qty Req	Order Quantity
20	R104-8301	104-8301, 104-9301, 109-6658, 133-7570	Locknut - 3/8-16 Nylon Flanged	27	
20	R32128-19	104-8301, 104-9301, 32128-19	Locknut - 3/8-16 Flanged Top Lock	27	
21	R110-1376	110-1376	Pivot Pin Assy	2	
22	R23-2790-01	23-2790, 23-2790-01	Blade - Scraper	1	
23	R3231-25	01-173-0610, 30-9970, 3231-25, 3231-3, 900064P	Bolt - Carriage 3/8-16 x 1-1/4	4	
24	R3290-355	01-159-0050, 3290-355, 58-5370	Pin - Bridge - Snap	2	
25	R283-60	283-60	Pin-Clevis	2	
26	R3230-2	01-173-0508, 25-25-AGD, 3230-16, 3230-2, 513624, 513633, 513635, 900038P	Bolt - Carriage	4	
27	R110-1395-03	110-1395-03	Tool Bar Assy	1	
28	R110-0259-03	110-0259-03	Scarifier Tine	15	
29	R323-13	01-150-1020, 01-178-0622, 20-54-AD, 20-54-AGD, 323-13, 513366	Bolt - Hex HD 3/8-16 x 2-3/4 GR5	15	
30	R3296-53	3296-53	Locknut - 5/8-11 ESNA Yellow	2	

All original equipment manufacturers names and part numbers are used for identification purposes only, and we are in no way implying that our products are original equipment parts. Prices subject to change without notice.



Replaces Toro Sand Pro 3040 Parts

Attachments

Finish Grader - Model 08754



Item No	R&R Part No.	OEM Part No.	Description	Qty Req	Order Quantity
31	R150346	3256-7	Washer - Thrust Plated 1-3/4x.750	2	
35	R112-1432	112-1432	Adapter Assy	1	
36	R3272-11	01-151-0010, 01-151-0040, 28-18-D, 28-28-D, 3211-72, 3272-11	Pin - Cotter	1	
37	R3256-26	01-166-0540, 01-166-0820, 17-2530, 24-13-BD, 30-8570, 3256-26, 356206, 48-9390	Washer - 1/2 in	2	
37	R455012	3256-26, 41-8440	Washer - Flat 1/2 x 3/4	2	
37	R87-7270-01	87-7270	Washer - Flat 1/2	2	
37	R453017	01-166-0050, 01-166-0240, 01-166-0800, 24-13-AD, 24-14-AD, 32-8110, 3256-26, 3256-6, 453017, 69-8980, 87-7270	Washer - Flat 1/2	2	
38	R283-83	283-83, 42194, 93-5343	Pin - Clevis	1	
39	R323-11	01-150-1440, 01-178-0618, 20-52-AD, 3224-7, 323-11	Bolt - 3/8-16 x 2 1/4 GR5	1	

All original equipment manufacturers names and part numbers are used for identification purposes only, and we are in no way implying that our products are original equipment parts. Prices subject to change without notice.



Replaces Toro Sand Pro 3040 Parts

Attachments

Finish Grader - Model 08754



Item No	R&R Part No.	OEM Part No.	Description	Qty Req	Order Quantity
39	R323-10	01-150-0680, 01-178-0616, 100-6663, 100-8320, 1489, 20-51-AD, 20-51-AGD, 3224-6, 323-10, 323-35, 908336	Bolt - Hex HD 3/8-16 x 2	1	
39	R101526	01-150-0970, 01-178-0620, 20-53-AGD, 321-11, 3224-8, 323-11, 323-12, 323-31, 323-4, 323-47	Bolt - Hex HD 3/8-16 x 2-1/2 GR5	1	
39	R400120	01-150-0990, 01-178-0416, 02-150-0990, 321-11, 3222-4, 33114-010, 33114-060, 513327, 908470	Bolt - Hex HD 1/4-20 x 2	1	
39	R400258	01-150-0800, 01-178-0600, 01-178-0606, 20-45-AD, 31-0200, 31-9910, 3224-1, 323-4	Bolt - Hex HD 3/8-16 x 3/4	1	
40	R110-8154	110-8154	Latch Assy	1	
41	R3296-44	3296-44	Nut - 3/8-16 Heavy Jam ESNA Lock	2	
47	R92-7008	92-7008	Rod End - Female	2	

All original equipment manufacturers names and part numbers are used for identification purposes only, and we are in no way implying that our products are original equipment parts. Prices subject to change without notice.



Replaces Toro Sand Pro 3040 Parts

Attachments

Finish Grader - Model 08754



Item No	R&R Part No.	OEM Part No.	Description	Qty Req	Order Quantity
48	R3220-3	01-191-0624, 3220-3, 3290-149	Nut - Jam Ball Joint	2	
49	R110-8108	110-8108	Rod - Link	1	
51	R110-8111-01	110-8111-01	Yoke Assy	1	
52	R110-8110	110-8110	Spacer	1	
53	R110-8116	110-8116	Spacer - Link	3	
54	R66-7230	66-7230	Spring - Compression	1	
55	R110-8114	110-8114	Washer	1	
56	R3211-12	3211-12	Bolt - Hx HD 3/8-24	1	
57	R32128-12	32128-12	Locknut - 3/8-24 Flanged Top Lock	1	
58	R110-8105	110-8105	Link Assy	1	
59	R3296-25	30-3380, 32127-21, 32127-31, 3290-160, 3290-33, 3296-13, 3296-25, 3296-45, 329645	Locknut - 1/2-13 Heavy ESNA	1	
60	R3234-34	321-11, 323-12, 3234-34	Bolt - Hex Washer 1/4 x 2	1	
61	R106-5517	106-5517	Decal - Warning Hot Surface	1	
62	R99-2058	99-2058	Spacer-Support, Ha	1	

All original equipment manufacturers names and part numbers are used for identification purposes only, and we are in no way implying that our products are original equipment parts. Prices subject to change without notice.