

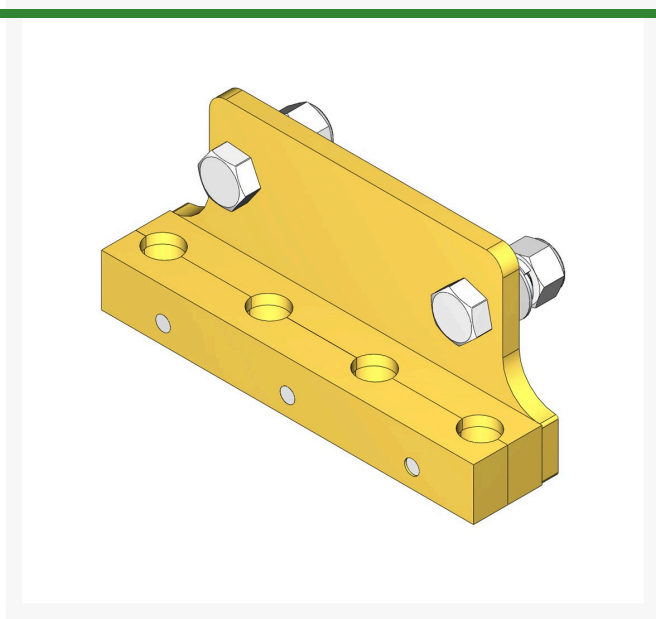

Tine Holder Assy - 4 Tine 7/8 Mt

R100-7617



Replaces

Toro 100-7617

Specifications

Manufacturer R&R Products

Fits Models

Toro ProCore 440
Toro ProCore 660
Toro ProCore 880

Replacement Parts

R33028-00	Locknut - 16mm x 2.0 ESNA
R33098-00	Flatwasher - 16mm
R33115-050	Bolt - Hex HD M10-1.5 x 50
R33118-045	Bolt - Hex HD M16-2.0 x 45
R48-9590	Washer - Lock 10mm

TURF Handels GmbH

Am Hartboden 48 Gratkorn, 8101
+43 3124 29064-17

<https://turf.rrproducts.com/>